

Crimp-Rast-Buchsengehäuse & Buchsenkontakte, 2-reihig, RM 4,20mm Friction Lock Female Housings & Contacts, Double Row, 4.20mm Pitch

Technische Daten / Technical Data

Isolierkörper <i>Insulator</i>	Thermoplast, UL94 V-2 (-0: UL94 V-0) <i>Thermoplastic, UL94 V-2 (-0: UL94 V-0)</i>
Kontaktmaterial <i>Contact Material</i>	Kupferlegierung <i>Copper alloy</i>
Kontaktfläche <i>Contact Surface</i>	Lt. Oberflächenoptionen, über Ni <i>Acc. to options (see below), over Ni</i>
Aderquerschnitt <i>Applicable wire Gauge</i>	AWG 24 ~ 20
Durchgangswiderstand <i>Contact Resistance</i>	< 20 mΩ
Isolationswiderstand <i>Insulation Resistance</i>	> 1000 MΩ
Spannungsfestigkeit <i>Test Voltage</i>	1,5 kV AC
Nennspannung <i>Voltage Rating</i>	600 V AC/DC
Nennstrom <i>Current Rating</i>	7 A AC/DC
Temperaturbereich <i>Temperature Range</i>	-25 °C ... +85 °C

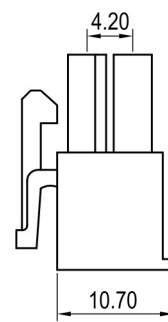
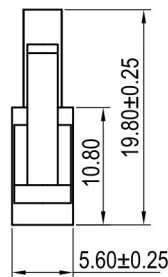
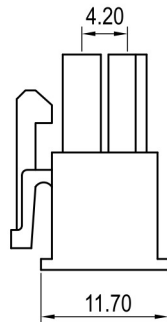
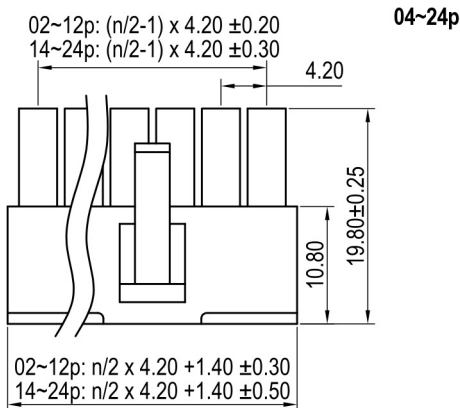
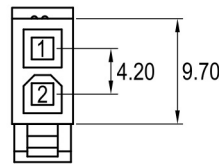
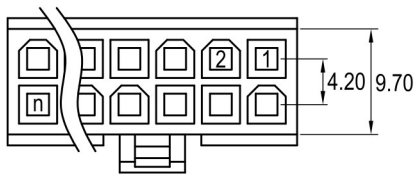
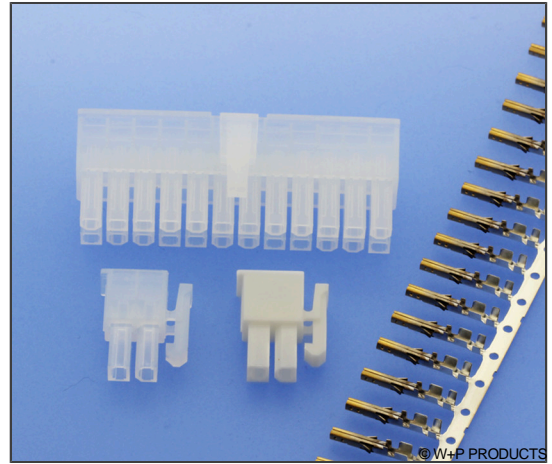

Series

544

Contacts*

12

02-24 Zweireihig
Double row

Type

01

01 Buchsengehäuse
Housing for female contacts

Material*

..

[] Für Wellenlöten, UL94 V-2
For wave soldering, UL94 V-2
0 Für Wellenlöten, UL94 V-0
For wave soldering, UL94 V-0

544

Crimp-Rast-Buchsengehäuse & Buchsenkontakte, 2-reihig, RM 4,20mm Friction Lock Female Housings & Contacts, Double Row, 4.20mm Pitch

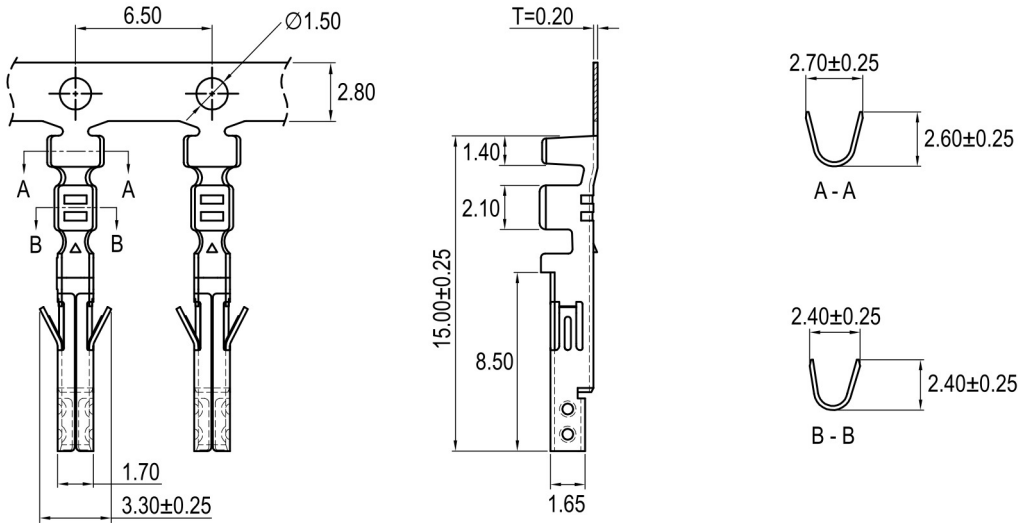

Series

544

Contacts

01

01 Für Crimp-Kontakt
For crimp terminal

Type

02

02 Buchsenkontakt
Female contact

Plating*

50

00 Vergoldet
Gold plated
50 Verzinkt
Tin plated

* Dies ist ein **Bestellbeispiel** -
bitte durch Ihre Spezifikationen ersetzen.
* This is an **order example** -
please replace by your specifications.