

SMT-Crimp-Rast-Stift-/Buchsenleisten RM 1,25mm, stehend/liegend SMT Friction Lock Headers / Crimp Housings, 1.25mm Pitch, Vertical/Horizontal

Technische Daten / Technical Data

Isolierkörper <i>Insulator</i>	Thermoplast, nach UL94 V-0 <i>Thermoplastic, rated UL94 V-0</i>
Kontaktmaterial <i>Contact Material</i>	Vierkantstift 0,75x0,30mm, Kupferlegierung <i>Rectangle pin 0.75x0.30mm, Copper alloy</i>
Aderquerschnitt <i>Applicable wire Gauge</i>	AWG 32 ~ 28
Durchgangswiderstand <i>Contact Resistance</i>	< 20 mΩ
Isolationswiderstand <i>Insulation Resistance</i>	> 100 MΩ
Spannungsfestigkeit <i>Test Voltage</i>	250 V AC
Nennspannung <i>Voltage Rating</i>	125 V AC
Nennstrom <i>Current Rating</i>	1 A
Temperaturbereich <i>Temperature Range</i>	-25 °C ... +85 °C
Verarbeitung <i>Processing</i>	Reflow-Lötverfahren <i>Reflow soldering</i>

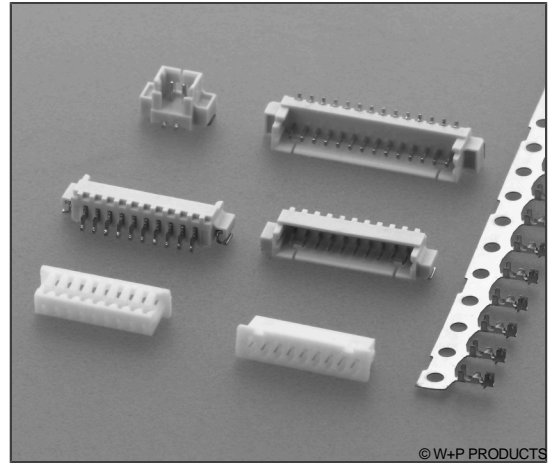

© W+P PRODUCTS

Passende Gegenstecker:
Compatible Connectors:

564

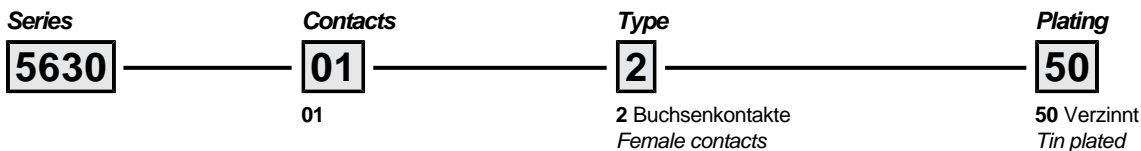
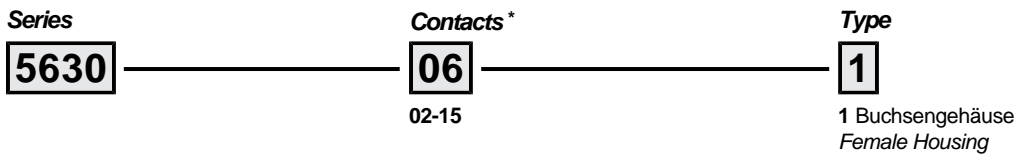
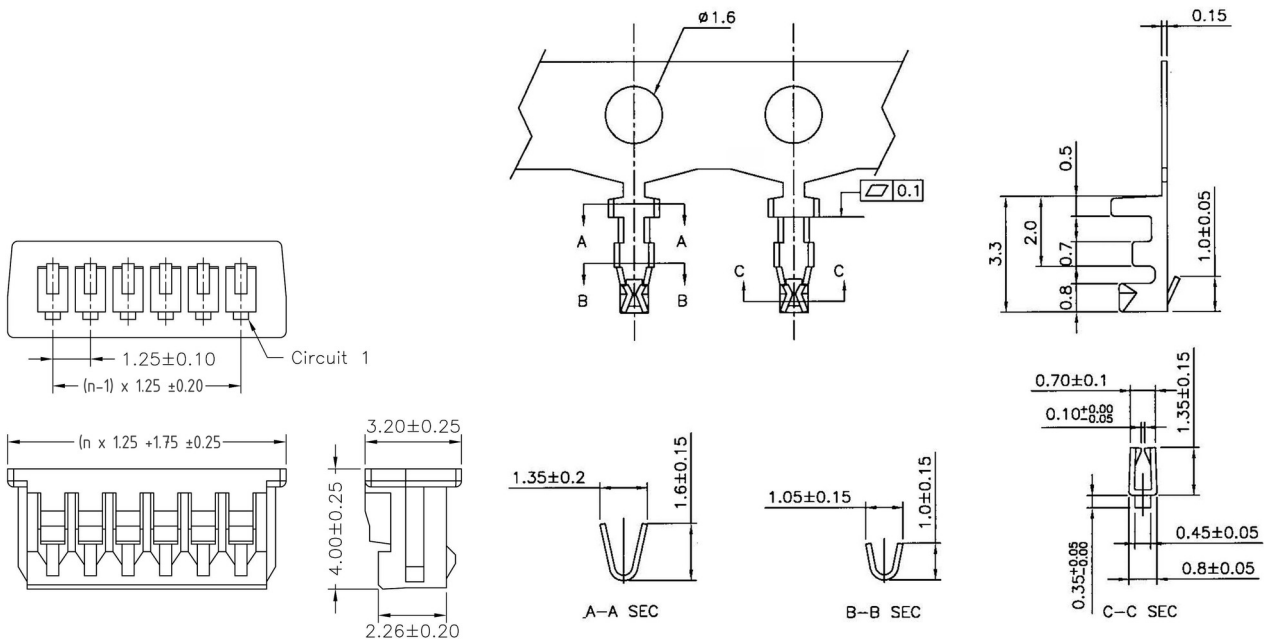

5630

SMT-Crimp-Rast-Stift-/Buchsenleisten RM 1,25mm, stehend/liegend
SMT Friction Lock Headers / Crimp Housings, 1.25mm Pitch, Vertical/Horizontal

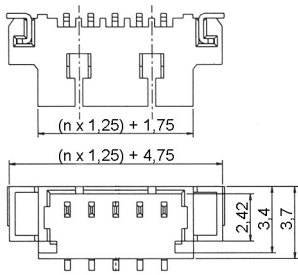

Type -3- vertical

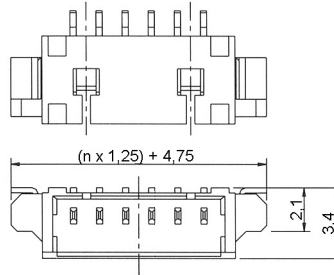

Type -4- horizontal

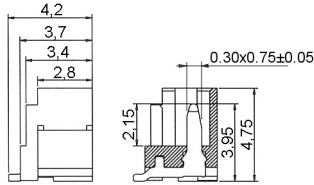
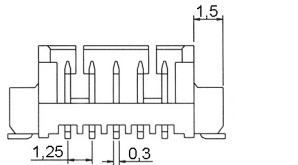

PCB-Layout

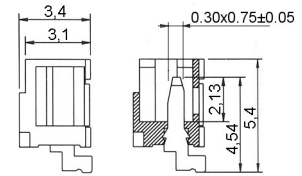
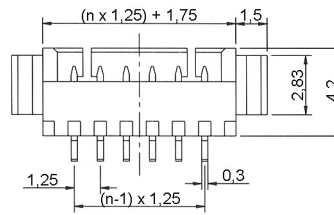

PCB-Layout

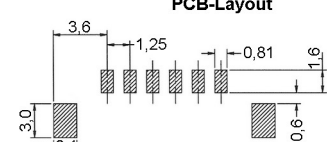
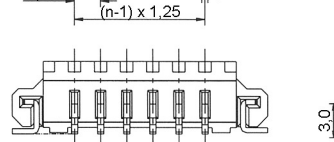
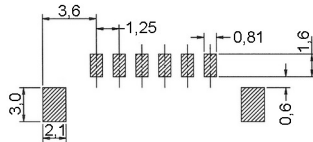
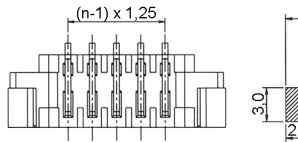

Series

5630

Contacts*

02

02-15

Type*

3

3 Stiftleiste stehend
 Vertical pin header
 4 Stiftleiste liegend
 Horizontal pin header

Plating

50

50 Verzinkt
 Tin plated

Packaging*

TR

ST
 TR (Option)

* Dies ist ein **Bestellbeispiel** - bitte durch Ihre Spezifikationen ersetzen.
 * This is an **order example** - please replace by your specifications.

Lieferformen / Packaging Options:

ST In Stangen ohne Pick&Place-Pads / In tubes w/o Pick&Place-Pads
TR (Option) Tape & Reel / Tape & Reel

Reflow-Lötempfehlung für kurze Lötzeiten

Die Bauteile sollten gemäß folgendem Temperatur-Profil in Anlehnung an die IPC/JEDEC J-STD-020C für bleifreies Löten im Reflow-Verfahren verarbeitet werden (Maximalwerte).

Profileigenschaft	Kennwert
Temperatur Minimum T_{Smin}	150 °C
Temperatur Maximum T_{Smax}	200 °C
Dauer $T_{Smin} - T_{Smax}$	60 – 180s
Temperatur Lötbereich T_L	217 °C
Verweildauer oberhalb T_L	60 – 180s
Ramp-Up Rate $T_{Smax} - T_P$	max. 3 °C / s
Höchsttemperatur T_P	260±5 °C
Dauer Höchsttemperatur	20 – 40s
Ramp-Down Rate $T_{Pmax} - T_{Smin}$	6 °C / s
Dauer 25 °C – Höchsttemperatur T_P	max. 8m

Reflow Soldering Recommendation For Shorter Peak Times

Items should be soldered according to IPC/JEDEC J-STD-020C temperature profile for leadfree reflow soldering (maximum values).

Profile Feature	Key Values
Minimum Temperature T_{Smin}	150 °C
Maximum Temperatur T_{Smax}	200 °C
Duration $T_{Smin} - T_{Smax}$	60 – 180s
Soldering Range Temperature T_L	217 °C
Duration above T_L	60 – 180s
Ramp-Up Rate $T_{Smax} - T_P$	max. 3 °C / s
Peak Temperature T_P	260±5 °C
Duration Peak Temperature	20 – 40s
Ramp-Down Rate $T_{Pmax} - T_{Smin}$	6 °C / s
Duration 25°C - Peak Temp. T_P	max. 8min

