

D-Sub COAX 13W3/3W3 Kombinations-Steckverbinder, Lötkelche D-Sub COAX 13W3/3W3 Combination Connectors, Solder Cups

Technische Daten / Technical Data

Gehäuse <i>Shell</i>	Stahl vernickelt, verzinkt <i>Steel, nickel plated, tin plated</i>
Isolierkörper <i>Insulator</i>	Thermoplast, nach UL94 V-0 <i>Thermoplastic, rated UL94 V-0</i>
Kontaktmaterial	Power-Stiftkontakte: Messing gedreht Power-Buchsenkontakte: Phosphorbronze gedreht Signal-Stift-/Buchsenkontakte: Messing gedreht <i>Power male contacts: Screw machined brass</i> <i>Power female contacts: Screw machined phosphor bronze</i> <i>Signal contacts: Screw machined brass</i>
Contact Material	Power: 0,75µm Gold im Steckbereich über Nickel Signal: 0,4µm Gold im Steckbereich über Nickel <i>Power: 0,75µm gold in mating area over nickel</i> <i>Signal: 0,4µm gold in mating area over nickel</i>
Kontaktoberfläche	AWG 20 max. (für Signalkontakte) <i>AWG 20 max. (for signal contacts)</i>
Contact Surface	
Aderquerschnitt <i>Applicable wire Gauge</i>	
Durchgangswiderstand <i>Contact Resistance</i>	< 20 mΩ
Isolationswiderstand <i>Insulation Resistance</i>	> 1000 MΩ
Spannungsfestigkeit <i>Test Voltage</i>	1 kV RMS
Nennstrom	Power-Kontakt: 10 A, 20 A, 40 A Signal-Kontakt: 5 A <i>Power contact: 10 A, 20 A, 40 A</i> <i>Signal contact: 5 A</i>
Current Rating	
Temperaturbereich <i>Temperature Range</i>	-55 °C ... +125 °C
Verarbeitung <i>Processing</i>	Wellenlötverfahren <i>Wave soldering</i>



© W+P PRODUCTS

Weitere Bauformen erhältlich:
More types available:
**2W2, 5W1, 5W5, 7W2, 8W8,
11W1, 21W4, 36W4**

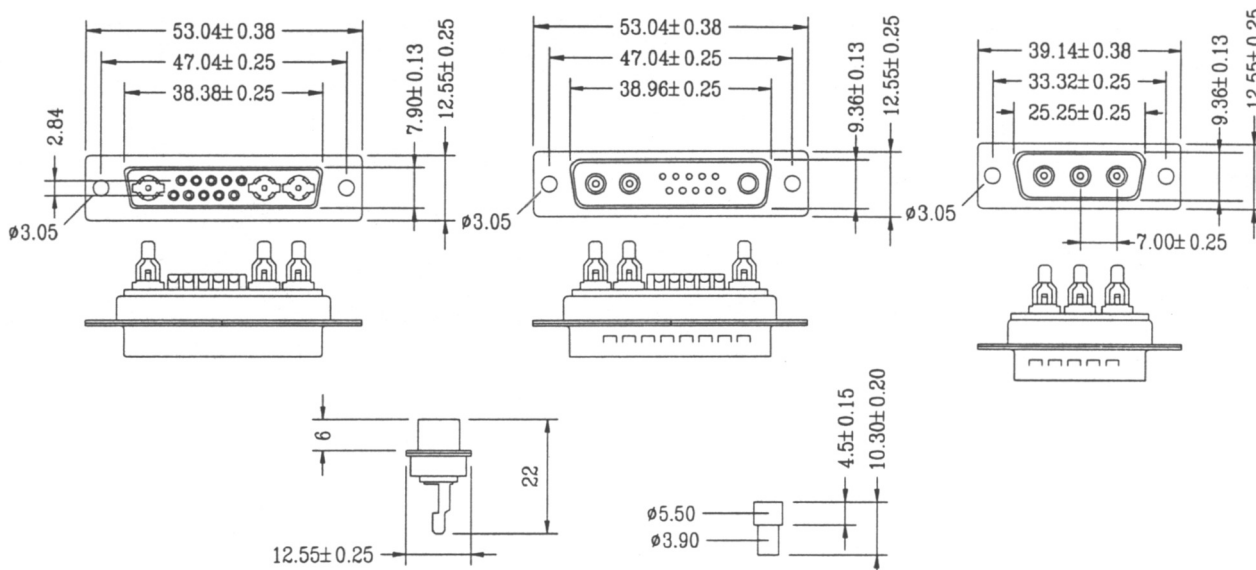

Series

636

Contacts*

13

13 10 Signalkontakte 3 Koaxialkontakte (Größe 8)
10 signal contacts and 3 coaxial contacts (size 8)
03 3 Koaxialkontakte (Größe 8), nur Stiftversion
3 coaxial contacts (size 8), only male version

Type*

1

1 Stift
Male
2 Buchse
Female

Mounting*

0

0-6/B1/B2/BL/CL Lt. tech. Info
Please refer Tech. Info.

* Dies ist ein **Bestellbeispiel** -
bitte durch Ihre Spezifikationen ersetzen.
* This is an **order example** -
please replace by your specifications.

D-Sub Befestigungsoptionen

Mounting Options

Durchgangsloch / Through Hole

0 Durchgangsloch 3,05mm
3.05mm Through Hole

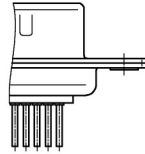

Gewindeniet vorn / Thread Rivet Front

B1 Gewindeniet UNC 4-40 (Anzugdrehmoment 0,4 Nm max.)
UNC 4-40 Thread Rivet (Tightening Torque 0.4 Nm max.)

B2 Gewindeniet M3 (Anzugdrehmoment 0,3 Nm max.)
M3 Thread Rivet (Tightening Torque 0.3 Nm max.)

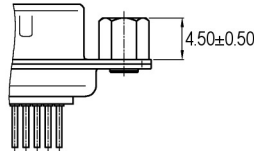

Gewindeniet hinten / Thread Rivet Back

1 Gewindeniet UNC 4-40 (Anzugdrehmoment 0,4 Nm max.)
UNC 4-40 Thread Rivet (Tightening Torque 0.4 Nm max.)

2 Gewindeniet M3 (Anzugdrehmoment 0,3 Nm max.)
M3 Thread Rivet (Tightening Torque 0.3 Nm max.)

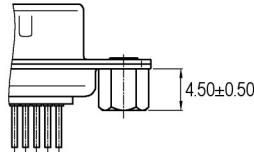

Gewindebolzen vorn / Thread Bolt Front

3 Gewindebolzen UNC 4-40 (Anzugdrehmoment 0,4 Nm max.)
UNC 4-40 Thread Bolt (Tightening Torque 0.4 Nm max.)

4 Gewindebolzen M3 (Anzugdrehmoment 0,3 Nm max.)
M3 Thread Bolt (Tightening Torque 0.3 Nm max.)

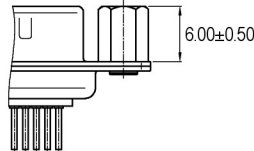

Gewindebolzen hinten / Thread Bolt Back

5 Gewindebolzen UNC 4-40 (Anzugdrehmoment 0,4 Nm max.)
UNC 4-40 Thread Bolt (Tightening Torque 0.4 Nm max.)

6 Gewindebolzen M3 (Anzugdrehmoment 0,3 Nm max.)
M3 Thread Bolt (Tightening Torque 0.3 Nm max.)

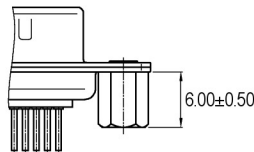

Board Locks

BL Board Lock mit UNC 4-40 Gewinde (Anzugdrehmoment 0,4 Nm max.)
Board Lock with UNC 4-40 Thread (Tightening Torque 0.4 Nm max.)

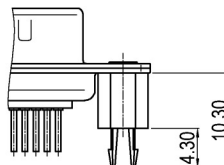

Combi-Locks

CL Combi-Lock mit UNC 4-40 Gewinde (Anzugdrehmoment 0,4 Nm max.)
Combi Lock with UNC 4-40 Thread (Tightening Torque 0.4 Nm max.)

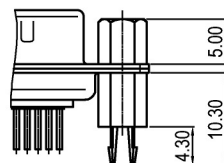

Empfehlungen für das Wellenlötverfahren

Recommendations for Wave Soldering

Die Bauteile sollten bei einer Lötbadtemperatur von 260°C in max. 5 Sekunden verlötet werden.

Empfohlenes Wellenlötprofil:

