

Technische Daten / Technical Data

Isolierkörper <i>Insulator</i>	Thermoplast, nach UL94 V-0 <i>Thermoplastic, rated UL94 V-0</i>
Kontaktmaterial <i>Contact Material</i>	Kupferlegierung <i>Copper alloy</i>
Kontaktoberfläche <i>Contact Surface</i>	Lt. Oberflächenoptionen, über Ni <i>Acc. to plating options, over Ni</i>
Durchgangswiderstand <i>Contact Resistance</i>	< 10 mΩ
Isolationswiderstand <i>Insulation Resistance</i>	> 10000 MΩ
Spannungsfestigkeit <i>Test Voltage</i>	1390 V AC
Nennspannung <i>Voltage Rating</i>	180 V AC/DC Max.
Nennstrom <i>Current Rating</i>	Siehe Tabelle unten <i>According to table below</i>
Temperaturbereich <i>Temperature Range</i>	-55 °C ... +125 °C
Verarbeitung <i>Processing</i>	Reflow-Lötverfahren 260 °C / 10 sec. max. <i>Reflow soldering 260 °C / 10 sec. max.</i>

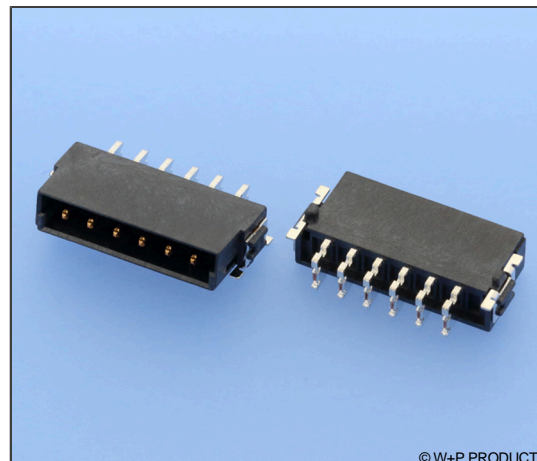

© W+P PRODUCTS

Gegenstecker / Mating Connectors:
9027 9028

Recommended P.C.B Layout (Top Side) (PCB Board TOLERANCE ±0.05)

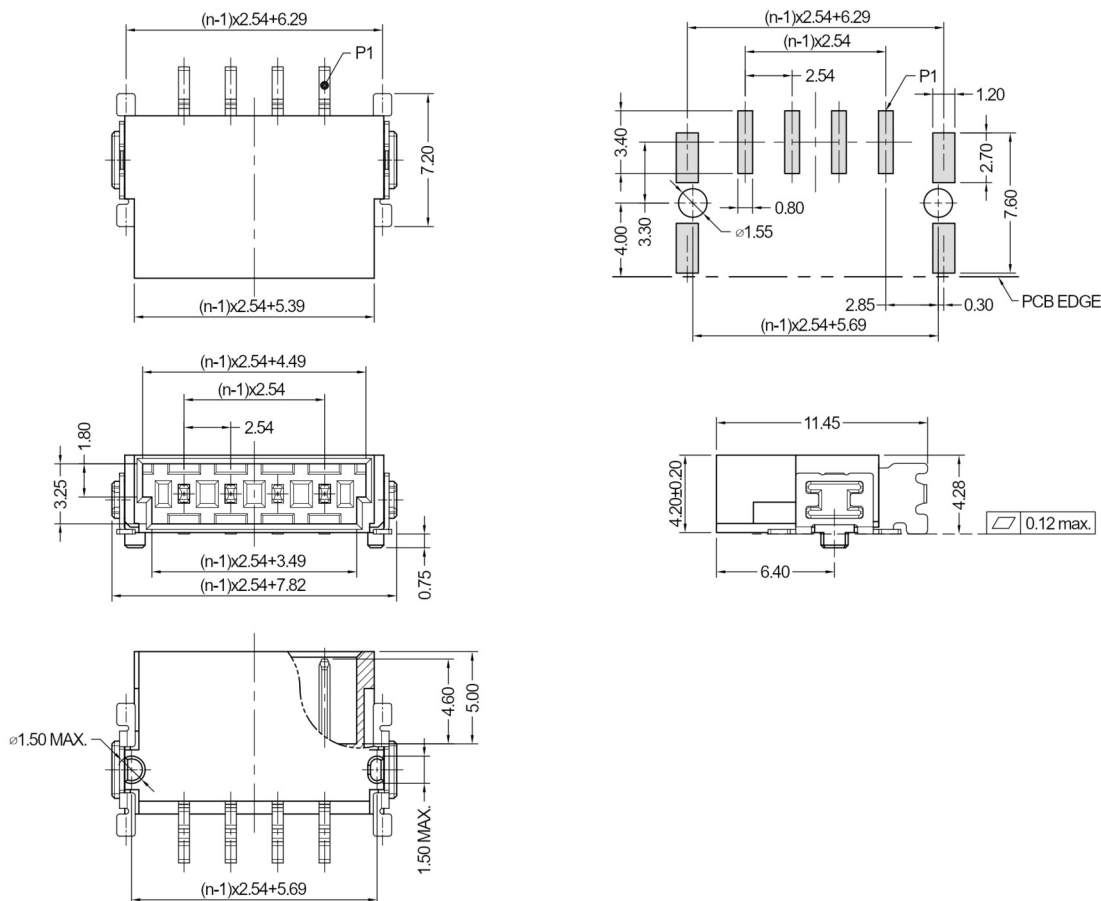

Series

9029

Contacts*

04

02/03/04/05/06/12

Plating*

60

60 Sel. Au flash / Sn over Ni
80 Sel. Au 30µ" / Sn over Ni

Packing

TR

TR Tape & Reel ohne Pick&Place-Pads
Tape & reel w/o Pick & Place Pads

* Dies ist ein **Bestellbeispiel** -
bitte durch Ihre Spezifikationen ersetzen.
* This is an **order example** -
please replace by your specifications.

9027 9028 9029 9030

Nennströme und Bauhöhen
Current Ratings and Mating Heights

Nennströme in Abhängigkeit von Polzahl und Gegenstecker

Current Ratings in accordance to Contact Number and Mating Connector

Mating Pair	2 Contacts	3-6 Contacts	12 Contacts
9027-2029	21 A max.	15 A max.	12 A max.
9028-9029	19 A max.	13 A max.	10 A max.
9027-9030	19 A max.	13 A max.	10 A max.
9028-9030	19 A max.	13 A max.	10 A max.

Bauhöhendiagramme

Diagrams of Mating Pairs

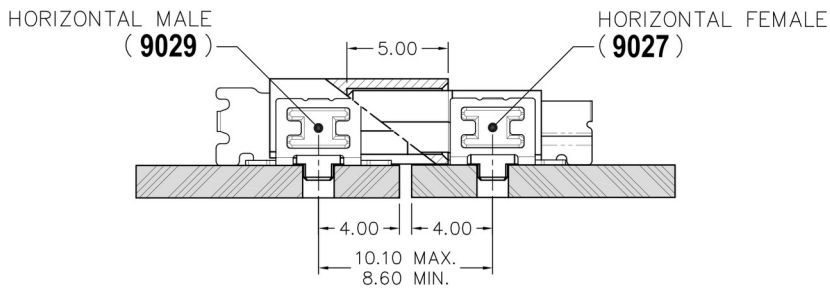

Mating Application - Extender Card

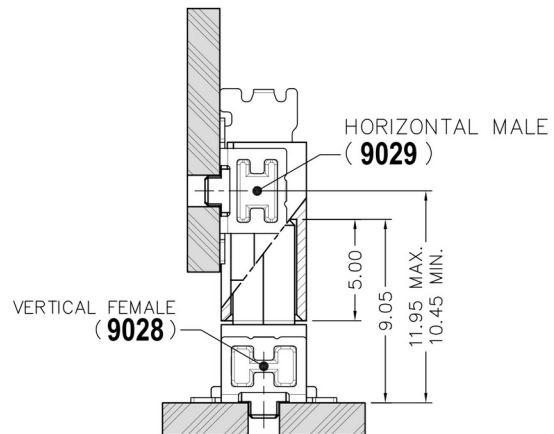

Mating Application - Daughter Card to Motherboard

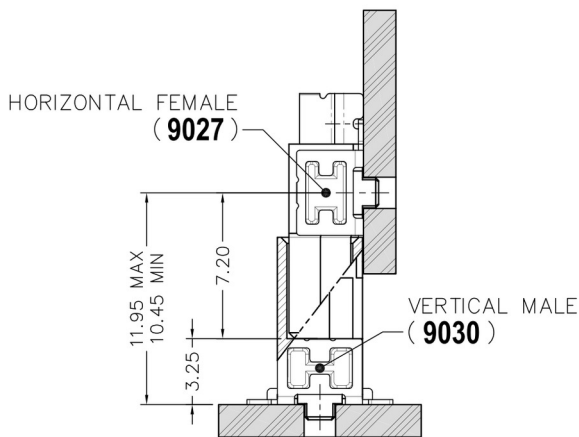

Mating Application - Daughter Card

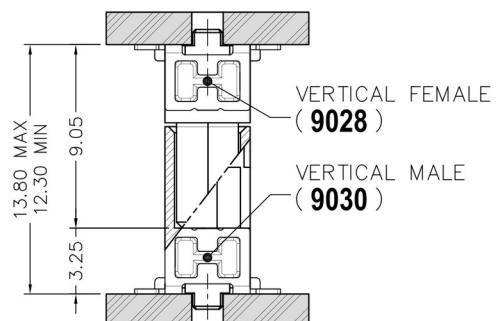

Mating Application - Board to Board Stacking

Informationen zum kurzen Reflow-Lötverfahren Fast Profile Reflow Soldering Information

Reflow-Lötempfehlung für kurze Lötzeiten

Die Bauteile sollten gemäß folgendem Temperatur-Profil in Anlehnung an die IPC/JEDEC J-STD-020C für bleifreies Löten im Reflow-Verfahren verarbeitet werden (Maximalwerte).

Profileigenschaft	Kennwert
Temperatur Minimum T_{Smin}	150°C
Temperatur Maximum T_{Smax}	200°C
Dauer $T_{Smin} - T_{Smax}$	120-150s
Temperatur Lötbereich T_L	230°C
Verweildauer oberhalb T_L	60s max.
Ramp-Up Rate $T_{Smax} - T_P$	max. 1,5°C / s
Höchsttemperatur T_P	260°C max.
Dauer Höchsttemperatur	5-10s
Ramp-Down Rate $T_{Pmax} - T_{Smin}$	3°C / s
Dauer 25°C - Höchsttemperatur T_P	Max. 4,5min

Reflow Soldering Recommendation For Shorter Peak Times

Items should be soldered according to IPC/JEDEC J-STD-020C temperature profile for leadfree reflow soldering (maximum values).

Profile Feature	Key Values
Minimum Temperature T_{Smin}	150°C
Maximum Temperatur T_{Smax}	200°C
Duration $T_{Smin} - T_{Smax}$	120-150s
Soldering Range Temperature T_L	230°C
Duration above T_L	60s max.
Ramp-Up Rate $T_{Smax} - T_P$	max. 1.5°C / s
Peak Temperature T_P	260°C max.
Duration Peak Temperature	5-10s
Ramp-Down Rate $T_{Pmax} - T_{Smin}$	3°C / s
Duration 25°C - Peak Temp. T_P	Max. 4.5min

